

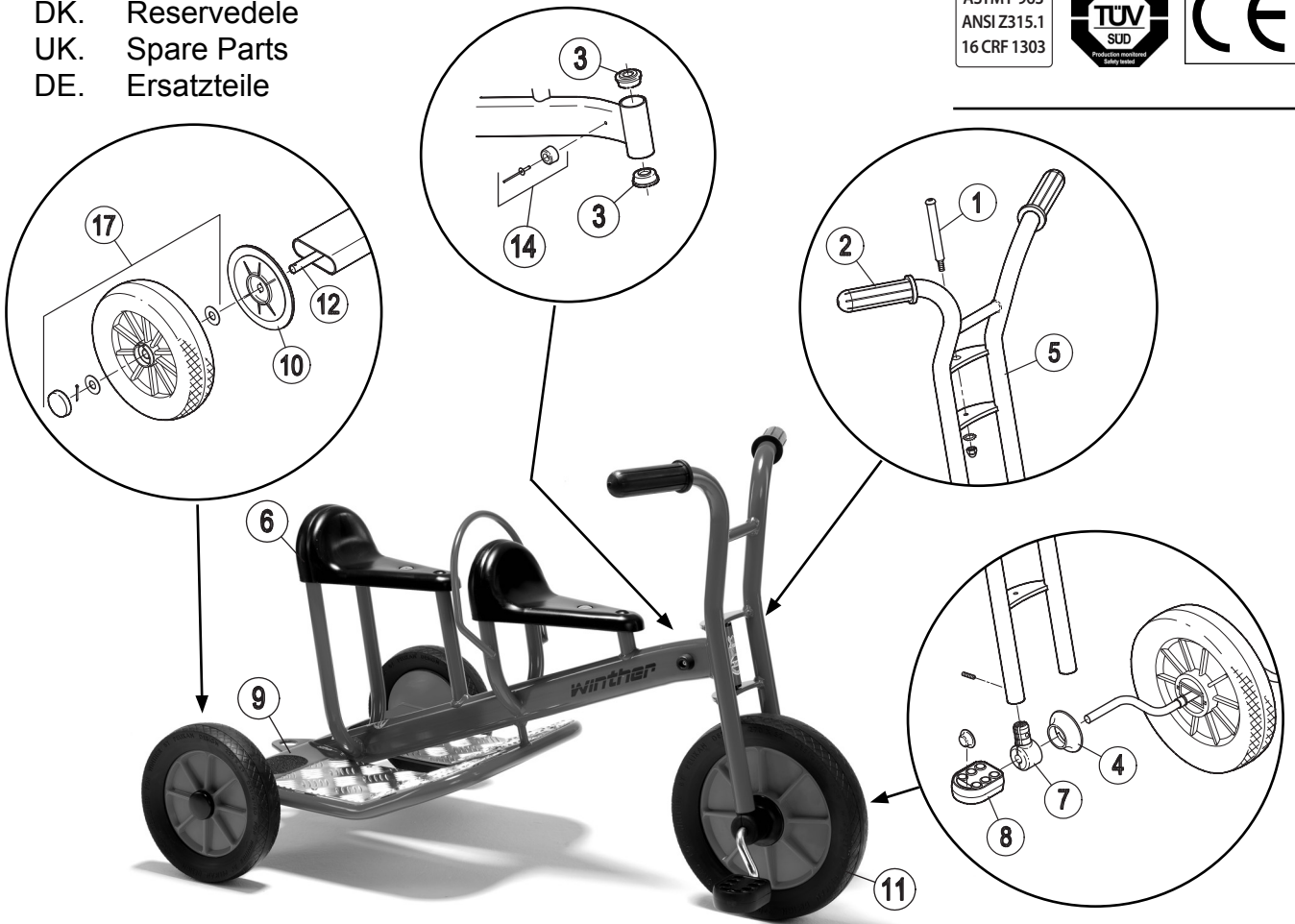



























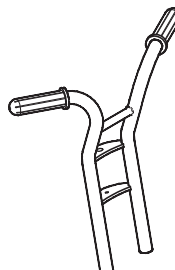











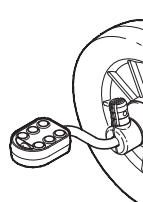
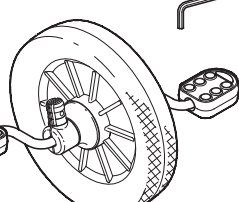

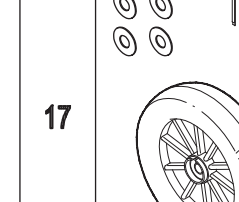



DK. Reservedele
 UK. Spare Parts
 DE. Ersatzteile

ASTM F 963
 ANSI Z315.1
 16 CRF 1303

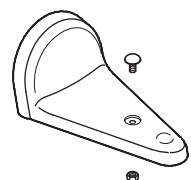
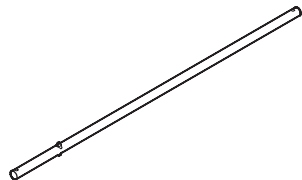

Pos.		Pos.		Pos.	
1	 x1  x2  x1	7	 x2  x2  x1	13	 x4  x2  x2
2	 x2  x2	8	 x2  x2	14	 x2  x2
3	 x2	9	 x2	15	
4	 x2	10	 x2	16	
5	           	11	     	17	       
6		12	  	18	

DK. Reservedele
 UK. Spare Parts
 DE. Ersatzteile

ASTM F 963
 ANSI Z315.1
 16 CRF 1303



46200								
Version								
Pos.	2.0							
1	50501							
2	50503							
3	50504							
4	50505							
5	50551							
6	50580							
7	50506							
8	50510							
9	50511							
10	50519							
11	50561							
12	50514							
13	50520							
14	50531							
15	-							
16	-							
17	50571							
18	-							